

Part Num.	Item Description	Exposed Trim	UPC# 046224 +	Ctn Qty	Ctn Wt	Line Art
ROLLER BALL STOP - U.S. PATENT # 5,428,847						
595RB	1 1/2" 20GA ROUGH BRASS	POLISHED CHROME	70343 3	5	19 lbs.	
597RB	1 1/2" 17GA ROUGH BRASS	POLISHED CHROME	70344 0	5	20 lbs.	
CONNECTED WASTE & OVERFLOW FOR LEG TUBS						
600SN	1 3/8" 22GA SATIN	POLISHED CHROME	93417 2	5	15 lbs.	
601SN	1 3/8" 17GA SATIN	POLISHED CHROME	93420 2	5	18 lbs.	
TILED IN TUBS CHAIN & STOPPER						
602RB	1 3/8" 22GA ROUGH BRASS	POLISHED CHROME	93429 5	5	15 lbs.	
604RB	1 1/2" 22GA ROUGH BRASS	POLISHED CHROME	93432 5	5	19 lbs.	

BRASS BATH DRAINS

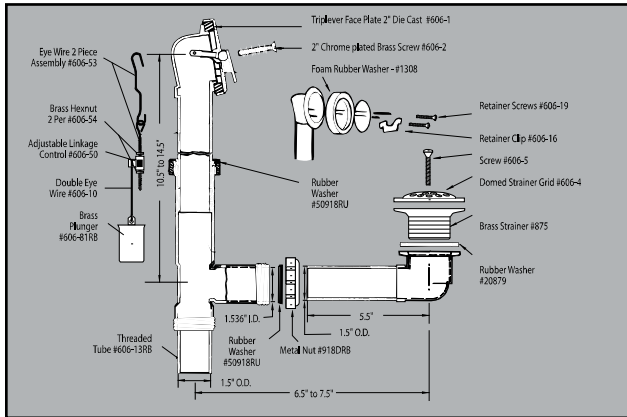

METAL BATH DRAIN BREAK DOWN

- FULL 1-1/2" CAST BRASS STRAINER FOR MAXIMUM DRAINAGE
- HIGH LUSTER FINISH ON EXPOSED PARTS
 - 4" OVERFLOW VERTICAL ADJUSTMENT
 - 2" WASTE SHOE HORIZONTAL ADJUSTMENT
 - 2" LONG BRASS FACE PLATE SCREWS
- ONE MAN INSTALLATION RETAINER CLIP
 - BAR CODED LABEL

TRIPLEVER						
606RB	1 1/2" 20GA ROUGH BRASS	POLISHED CHROME	70037 1	5	19 lbs.	
606RBDS	1 1/2" 20GA ROUGH BRASS	PVD/POLISHED BRASS*	00262 8	5	19 lbs.	
607RB	1 1/2" 17GA ROUGH BRASS	POLISHED CHROME	93466 0	5	19 lbs.	
TRIPLEVER - WITH RETAINER CLIP						
605RB	1 1/2" 20GA ROUGH BRASS	POLISHED CHROME	93437 0	5	19 lbs.	
605LARB	1 1/2" 20GA ROUGH BRASS	POLISHED CHROME	10736 3	5	19 lbs.	
605RBDS	1 1/2" 20GA ROUGH BRASS	PVD/POLISHED BRASS*	00255 0	5	19 lbs.	
608RB	1 1/2" 17GA ROUGH BRASS	POLISHED CHROME	93470 7	5	19 lbs.	
TRIPLEVER GARDEN TUB						
609RB	1 1/2" 20GA ROUGH BRASS	POLISHED CHROME	93472 1	5	23 lbs.	
609RBDS	1 1/2" 20GA ROUGH BRASS	PVD/POLISHED BRASS*	00261 8	5	23 lbs.	
615RB	1 1/2" 17GA ROUGH BRASS	POLISHED CHROME	93492 9	5	24 lbs.	
615RBDS	1 1/2" 17GA ROUGH BRASS	PVD/POLISHED BRASS*	00258 1	5	24 lbs.	
615RBBN	1 1/2" 17GA ROUGH BRASS BRASS NUTS	POLISHED CHROME	00615 2	1	5.0 lbs.	

* "PVD" is a tarnish free product

Part Num.	Item Description	Exposed Trim	UPC# 046224 +	Ctn Qty	Ctn Wt	Line Art
LIFT 'N TURN DIE CAST						
610ARB	1 1/2" 20GA ROUGH BRASS	POLISHED CHROME	93480 6	5	18 lbs.	
610ARBGT	1 1/2" 20GA ROUGH BRASS GARDEN TUB	POLISHED CHROME	01658 8	1	4 lbs.	
LIFT 'N TURN BRASS						
610RB	1 1/2" 20GA ROUGH BRASS	POLISHED CHROME	70038 8	5	19 lbs.	
610RBDS	1 1/2" 20GA ROUGH BRASS	PVD/POLISHED BRASS*	00231 4	5	19 lbs.	
611RB	1 1/2" 17GA ROUGH BRASS	POLISHED CHROME	93482 0	5	20 lbs.	
611RBDSGT	1 1/2" 17GA ROUGH BRASS GARDEN TUB	PVD/POLISHED BRASS*	01676 2	1	5 lbs.	
FOOT LOK STOP™						
612RB	1 1/2" 20GA ROUGH BRASS	POLISHED CHROME	70039 5	5	19 lbs.	
MECHANICAL POP-UP						
617RB	1 1/2" 20GA ROUGH BRASS	POLISHED CHROME	93499 8	5	19 lbs.	
TRIM KITS						
64-99PC	TRIPLEVER TRIM KIT	POLISHED CHROME	93600 8	10	5 lbs.	
64-99AN	TRIPLEVER TRIM KIT	ANTIQUE BRASS	00264 2	10	5 lbs.	
64-99DS	TRIPLEVER TRIM KIT	PVD/POLISHED BRASS*	93599 5	10	5 lbs.	
64-99WH	TRIPLEVER TRIM KIT	WHITE	72259 5	10	5 lbs.	
62-99PC	LIFT 'N TURN TRIM KIT WITH 2 HOLE FACEPLATE AND SCREWS	POLISHED CHROME	72071 3	10	5 lbs.	
62-99AN	LIFT 'N TURN TRIM KIT WITH 2 HOLE FACEPLATE AND SCREWS	ANTIQUE BRASS	93507 0	10	5 lbs.	
62-99DS	LIFT 'N TURN TRIM KIT WITH 2 HOLE FACE PLATE AND SCREWS	PVD/POLISHED BRASS*	00224 6	10	5 lbs.	
62-99WH	LIFT 'N TURN TRIM KIT WITH 2 HOLE FACE PLATE AND SCREWS	WHITE	72260 1	10	5 lbs.	
63-99PC	FOOT LOK STOP™ TRIM KIT WITH 2 HOLE FACE PLATE AND SCREWS	POLISHED CHROME	70751 6	10	5 lbs.	
63-99AN	FOOT LOK STOP™ TRIM KIT WITH 2 HOLE FACE PLATE AND SCREWS	ANTIQUE BRASS	93571 1	10	5 lbs.	
63-99DS	FOOT LOK STOP™ TRIM KIT WITH 2 HOLEFACE PLATE AND SCREWS	PVD/POLISHED BRASS*	00239 0	10	5 lbs.	
63-99WH	FOOT LOK STOP™ TRIM KIT WITH 2 HOLE FACE PLATE AND SCREWS	WHITE	72261 8	10	5 lbs.	
62-95PC	1 3/8" LIFT 'N TURN TRIM KIT WITH 2 HOLE FACEPLATE AND SCREWS WITH CONVERSION BUSHING	POLISHED CHROME	70746 2	10	5 lbs.	

Part Num.	Item Description	Exposed Trim	UPC# 046224 +	Ctn Qty	Ctn Wt	Line Art
TRIM KITS - CONTINUED						
62-95DS	1 3/8" LIFT 'N TURN TRIM KIT WITH 2 HOLE FACEPLATE AND SCREWS WITH CONVERSION BUSHING	PVD/POLISHED BRASS*	70747 9	10	5 lbs.	
62-95WH	1 3/8" LIFT 'N TURN TRIM KIT WITH 2 HOLE FACEPLATE AND SCREWS WITH CONVERSION BUSHING	WHITE	00251 2	10	5 lbs.	
65-99DS	ROLLERBALL TRIM KIT WITH 2 HOLE FACE PLATE AND SCREWS	PVD/POLISHED BRASS*	00253 6	10	5 lbs.	
66-99PC	ROLLERBALL TRIM KIT WITH SINGLE HOLE FACE PLATE AND SCREWS	POLISHED CHROME	73326 3	10	5 lbs.	
66-99DS	ROLLERBALL TRIM KIT WITH SINGLE HOLE FACE PLATE AND SCREWS	PVD/POLISHED BRASS*	00254 3	10	5 lbs.	
LINKAGE ASSEMBLY						
606-21	FOR TRIPLEVER 6" EYE WIRE, 10-32 BRASS EYE BOLT & BRASS CLEVIS PLUNGER		93451 6	25	8 lbs.	

TRIM KITS / PLASTIC BATH DRAINS

PLASTIC BATH DRAIN BREAK DOWN

- 1-1/2" IPS THREADED STRAINER
- ONE MAN INSTALLATION - TUB TACKS
- HIGH LUSTER FINISH ON EXPOSED PARTS
- 4-1/4" OVERFLOW VERTICAL ADJUSTMENT
- 2" WASTE SHOE HORIZONTAL ADJUSTMENT
- PRECISION MOLDED CONSTRUCTION
- 2" LONG BRASS FACE PLATE SCREWS
- BAR CODED LABEL

(ILLUSTRATION IS A 64 DELUXE TRIPLEVER (IN A 64, SUBSTITUTE A MOLDED PLASTIC STRAINER #82-W))

CHAIN & STOPPER						
61W	1 1/2" O.D. WHITE	POLISHED CHROME	93477 6	5	12 lbs.	
61CW	1 1/2" O.D. WHITE WITH CONDENSATE TUBE	POLISHED CHROME	72137 6	5	13 lbs.	
BRASS LIFT 'N TURN						
62W	1 1/2" O.D. WHITE	POLISHED CHROME	93517 9	5	8 lbs.	
62WDS	1 1/2" O.D. WHITE	PVD/POLISHED BRASS*	00222 2	5	8 lbs.	
62WDSBN	1 1/2" O.D. WHITE	PVD/BRUSHED NICKEL*	00997 9	5	8 lbs.	
62B	1 1/2" O.D. BLACK	POLISHED CHROME	93510 0	5	8 lbs.	
62BDS	1 1/2" O.D. BLACK	PVD/POLISHED BRASS*	00229 1	5	8 lbs.	

* "PVD" is a tarnish free product

PLASTIC BATH DRAINS

Part Num.	Item Description	Exposed Trim	UPC# 046224 +	Ctn Qty	Ctn Wt	Line Art
BRASS LIFT 'N TURN - CONTINUED						
62CW	1 1/2" O.D. WHITE WITH CONDENSATE TUBE	POLISHED CHROME	93516 2	5	8 lbs.	
METAL LIFT 'N TURN						
62AW	1 1/2" O.D. WHITE	POLISHED CHROME	93514 8	5	8 lbs.	
62AB	1 1/2" O.D. BLACK	POLISHED CHROME	93509 4	5	8 lbs.	
62AW-8	1 1/2" O.D. WHITE WITH 8" TAILPIECE	POLISHED CHROME	71269 5	5	10 lbs.	
62ACW	1 1/2" O.D. WHITE WITH CONDENSATE TUBE	POLISHED CHROME	93513 1	5	9 lbs.	
FOOT LOK STOP™						
63W	1 1/2" O.D. WHITE	POLISHED CHROME	93575 9	5	8 lbs.	
63WDS	1 1/2" O.D. WHITE	PVD/POLISHED BRASS*	00236 9	5	8 lbs.	
63TTW	1 1/2" O.D. WHITE - BAGGED	POLISHED CHROME	01494 2	50	70 lbs.	
63B	1 1/2" O.D. BLACK	POLISHED CHROME	93573 5	5	8 lbs.	
63BDS	1 1/2" O.D. BLACK	PVD/POLISHED BRASS*	00240 6	5	8 lbs.	
TRIPLEVER - WITH STRAINER AND DOME GRID						
64W	1 1/2" O.D. WHITE PLASTIC STRAINER	POLISHED CHROME	93610 7	5	7 lbs.	
64WDS	1 1/2" O.D. WHITE - PLASTIC STRAINER	PVD/POLISHED BRASS*	00257 4	5	7 lbs.	
64WWH	1 1/2" O.D. WHITE - PLASTIC STRAINER	WHITE	72051 5	5	7 lbs.	
64B	1 1/2" O.D. BLACK - PLASTIC STRAINER	POLISHED CHROME	93601 5	5	7 lbs.	
64BDS	1 1/2" O.D. BLACK - PLASTIC STRAINER	PVD/POLISHED BRASS*	00256 7	5	7 lbs.	
64BWH	1 1/2" O.D. BLACK - PLASTIC STRAINER	WHITE	72141 3	5	7 lbs.	
64CW	1 1/2" O.D. WHITE WITH CONDENSATE TUBE - PLASTIC STRAINER	POLISHED CHROME	93608 4	5	8 lbs.	
64WDELUXE	1 1/2" O.D. WHITE - BRASS STRAINER	POLISHED CHROME	93616 9	5	8 lbs.	
64WDELUXDS	1 1/2" O.D. WHITE - BRASS STRAINER	PVD/POLISHED BRASS*	00259 8	5	8 lbs.	
64BDELUXE	1 1/2" O.D. BLACK - BRASS STRAINER	POLISHED CHROME	93606 0	5	8 lbs.	
MECHANICAL POP-UP						
67W	1 1/2" O.D. WHITE 	POLISHED CHROME	93632 9	5	8 lbs.	
67B	1 1/2" O.D. BLACK	POLISHED CHROME	93630 5	5	8 lbs.	
ROLLER BALL STOPS - U.S. PATENT # 5,428,847						
84W	1 1/2" O.D. WHITE	POLISHED CHROME	70310 5	5	8 lbs.	
84WDS	1 1/2" O.D. WHITE	PVD/POLISHED BRASS*	00243 7	5	8 lbs.	

Part Num.	Item Description	Exposed Trim	UPC# 046224 +	Ctn Qty	Ctn Wt	Line Art
-----------	------------------	--------------	---------------	---------	--------	----------

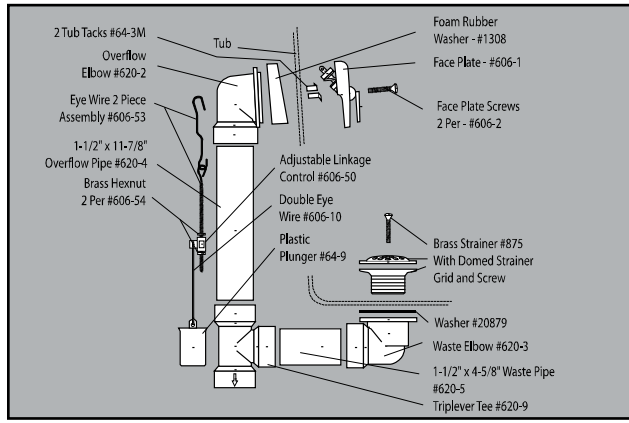

SCHEDULE 40 BATH DRAIN BREAK DOWN

- 1-1/2" IPS THREADED STRAINER
- HIGH LUSTER FINISH ON EXPOSED PARTS
- QUICK ADJUST LINKAGE ASSEMBLY
- ALL SCHEDULE 40 AVAILABLE LESS PIPE
- PRECISION MOLDED OVERFLOW, WASTE SHOE AND TEE
 - 2" LONG BRASS FACE PLATE SCREWS
- ONE MAN INSTALLATION - TUB TACKS
 - BAR CODED LABEL

(ILLUSTRATION IS A 640 TRIPLEVER - INDUSTRY EXCLUSIVE SCHEDULE 40 TRIPLEVER)

PLASTIC BATH DRAINS
SCHEDULE 40 DRAINS

SCH. 40 - BRASS LIFT 'N TURN - WITH PIPE & TEE

620PVC	1 1/2" SCH 40 PVC	POLISHED CHROME	70053 1	5	13 lbs.
620PVCDS	1 1/2" SCH 40 PVC	PVD/POLISHED BRASS*	00221 5	5	13 lbs.
620PVCWH	1 1/2" SCH 40 PVC	WHITE	71273 2	5	13 lbs.
620ABS	1 1/2" SCH 40 ABS	POLISHED CHROME	70041 8	5	13 lbs.
620ABSDES	1 1/2" SCH 40 ABS	PVD/POLISHED BRASS*	00225 3	5	13 lbs.

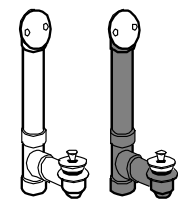

SCH. 40 - L.A. APPROVED - BRASS LIFT 'N TURN - WITH PIPE & TEE & ONE HOLE FACE PLATE

620LAPVC	1 1/2" SCH 40 PVC	POLISHED CHROME	70499 7	5	13 lbs.
620LAPVCWH	1 1/2" SCH 40 PVC	WHITE	70478 2	5	13 lbs.
620LAABS	1 1/2" SCH 40 ABS	POLISHED CHROME	93535 3	5	13 lbs.

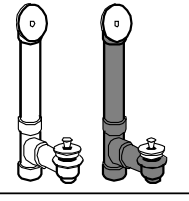

SCH. 40 - METAL LIFT 'N TURN - WITH PIPE & TEE

620APVC	1 1/2" SCH 40 PVC	POLISHED CHROME	93531 5	5	14 lbs.
620AABS	1 1/2" SCH 40 ABS	POLISHED CHROME	70998 5	5	14 lbs.
620ATTPVC	1 1/2" SCH 40 PVC - BAGGED	POLISHED CHROME	93534 6	10	14 lbs.

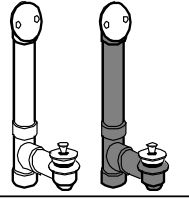

SCH. 40 - L.A. APPROVED - METAL LIFT 'N TURN - WITH PIPE & TEE & ONE HOLE FACE PLATE

620ALAPVC	1 1/2" SCH 40 PVC	POLISHED CHROME	00620 6	5	7 lbs.
-----------	-------------------	-----------------	---------	---	--------

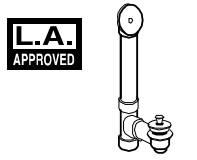

SCH. 40 - BRASS LIFT 'N TURN - HALF PAK LESS PIPE & TEE

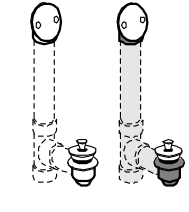

621PVC	1 1/2" SCH 40 PVC	POLISHED CHROME	93549 0	5	7 lbs.
621PVCDS	1 1/2" SCH 40 PVC	PVD/POLISHED BRASS*	00220 8	5	7 lbs.
621PVCWH	1 1/2" SCH 40 PVC	WHITE	71113 1	5	7 lbs.
621ABS	1 1/2" SCH 40 ABS	POLISHED CHROME	93539 1	5	7 lbs.
621ABSDES	1 1/2" SCH 40 ABS	PVD/POLISHED BRASS*	00227 7	5	7 lbs.
621ABSWH	1 1/2" SCH 40 ABS	WHITE	70561 1	5	7 lbs.



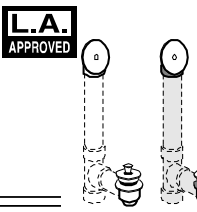

SCH. 40 - L.A. APPROVED - BRASS LIFT 'N TURN - LESS PIPE & TEE

621LAPVC	1 1/2" SCH 40 PVC	POLISHED CHROME	93547 7	5	7 lbs.
621LAPVCDS	1 1/2" SCH 40 PVC	PVD/POLISHED BRASS*	00232 1	5	7 lbs.
621LAPVCWH	1 1/2" SCH 40 PVC	WHITE	72268 7	5	7 lbs.
621LAABS	1 1/2" SCH 40 ABS	POLISHED CHROME	93545 2	5	7 lbs.



Part Num.	Item Description	Exposed Trim	UPC# 046224 +	Ctn Qty	Ctn Wt	Line Art
SCH. 40 - ZINC DIE CAST - LIFT 'N TURN HALF PAK - LESS PIPE & TEE						
621ACPVC	1 1/2" SCH 40 PVC WITH CONDENSATE TUBE	POLISHED CHROME	70615 1	5	7 lbs.	
621APVC	1 1/2" SCH 40 PVC	POLISHED CHROME	93544 5	5	7 lbs.	
621AABS	1 1/2" SCH 40 ABS	POLISHED CHROME	93538 4	5	7 lbs.	
621ALAPVC	1 1/2" SCH 40 PVC 1 HOLE FACEPLATE	POLISHED CHROME	93543 8	5	7 lbs.	
621ALAABS	1 1/2" SCH 40 ABS 1 HOLE FACEPLATE	POLISHED CHROME	93542 1	5	7 lbs.	
SCH. 40 - FOOT LOK STOP™ - WITH PIPE & TEE						
630PVC	1 1/2" SCH 40 PVC	POLISHED CHROME	70052 4	5	13 lbs.	
630PVCDS	1 1/2" SCH 40 PVC	PVD/POLISHED BRASS*	00237 6	5	13 lbs.	
630PVCWH	1 1/2" SCH 40 PVC	WHITE	71111 7	5	13 lbs.	
630ABS	1 1/2" SCH 40 ABS 	POLISHED CHROME	70040 1	5	13 lbs.	
630ABSDES	1 1/2" SCH 40 ABS	PVD/POLISHED BRASS*	00235 2	5	13 lbs.	
SCH. 40 - FOOT LOK STOP™ - WITH TEST PLUG						
630PVCTP	1 1/2" SCH 40 PVC	POLISHED CHROME	01581 9	1	3 lbs.	
630ABSTP	1 1/2" SCH 40 PVC	POLISHED CHROME	02105 6	1	3 lbs.	
SCH. 40 - L.A. APPROVED - FOOT LOK STOP™ - WITH PIPE & TEE & ONE HOLE FACE PLATE						
630LAPVC	1 1/2" SCH 40 PVC	POLISHED CHROME	70217 7	5	13 lbs.	
630LAPVCDS	1 1/2" SCH 40 PVC	PVD/POLISHED BRASS*	00275 8	5	13 lbs.	
630LAABS	1 1/2" SCH 40 ABS	POLISHED CHROME	93578 0	5	13 lbs.	
630LAABSDES	1 1/2" SCH 40 ABS	PVD/POLISHED BRASS*	00276 5	5	13 lbs.	
SCH. 40 - L.A. APPROVED 						
SCH. 40 - FOOT LOK STOP™ HALF PAK - LESS PIPE & TEE						
631PVC	1 1/2" SCH 40 PVC	POLISHED CHROME	93585 8	5	7 lbs.	
631PVCDS	1 1/2" SCH 40 PVC	PVD/POLISHED BRASS*	00234 5	5	7 lbs.	
631PVCWH	1 1/2" SCH 40 PVC	WHITE	72120 8	5	7 lbs.	
631ABS	1 1/2" SCH 40 ABS	POLISHED CHROME	93580 3	5	7 lbs.	
631ABSDES	1 1/2" SCH 40 ABS	PVD/POLISHED BRASS*	00238 3	5	7 lbs.	
SCH. 40 - L.A. APPROVED - FOOT LOK STOP™ HALF PAK - LESS PIPE & TEE						
631LAPVC	1 1/2" SCH 40 PVC	POLISHED CHROME	93583 4	5	7 lbs.	
631LAPVCDS	1 1/2" SCH 40 PVC	PVD/POLISHED BRASS*	00246 8	5	7 lbs.	
631LAABSDES	1 1/2" SCH 40 ABS	PVD/POLISHED BRASS*	00245 1	5	7 lbs.	
SCH. 40 - L.A. APPROVED 						

Part Num.	Item Description	Exposed Trim	UPC# 046224 +	Ctn Qty	Ctn Wt	Line Art
SCH. 40 - TRIPLEVER (SHOWN IN DETAIL ON PAGE 41) - WITH QUICK ADJUST LINKAGE						
640PVC	1 1/2" SCH 40 PVC	POLISHED CHROME	70241 2	5	13 lbs.	
640PVCDS	1 1/2" SCH 40 PVC	PVD/POLISHED BRASS*	00267 3	5	13 lbs.	
640ABS	1 1/2" SCH 40 ABS 	POLISHED CHROME	70341 9	5	13 lbs.	
640ABSDES	1 1/2" SCH 40 ABS	PVD/POLISHED BRASS*	00273 4	5	13 lbs.	
SCH. 40 - TRIPLEVER (SHOWN IN DETAIL ON PAGE 41) - WITH BRASS CLEVIS LINKAGE						
646PVC	1 1/2" SCH 40 PVC	POLISHED CHROME	02143 8	1	2 lbs.	
SCH. 40 - TRIPLEVER HALF PAK - LESS PIPE - QUICK ADJUST LINKAGE ADJUSTS FROM 14" TO 21 11/16"						
641PVC	1 1/2" SCH 40 PVC	POLISHED CHROME	70264 1	5	13 lbs.	
641PVCDS	1 1/2" SCH 40 PVC	POLISHED BRASS	00263 5	5	13 lbs.	
641ABS	1 1/2" SCH 40 ABS	POLISHED CHROME	70265 8	5	13 lbs.	
641ABSDES	1 1/2" SCH 40 ABS	PVD/POLISHED BRASS*	00274 1	5	13 lbs.	
SCH. 40 - ROLLER BALL STOP - U.S. PATENT # 5,428,847						
650PVC	1 1/2" SCH 40 PVC 	POLISHED CHROME	70340 2	5	11 lbs.	
650PVCDS	1 1/2" SCH 40 PVC	PVD/POLISHED BRASS*	00242 0	5	11 lbs.	
650PVCWH	1 1/2" SCH 40 PVC	WHITE	71127 8	5	11 lbs.	
650ABS	1 1/2" SCH 40 ABS	POLISHED CHROME	70495 9	5	11 lbs.	
SCH. 40 - ROLLER BALL STOP - U.S. PATENT # 5,428,847 - TWO HOLE FACE PLATE						
650PVCTP	1 1/2" SCH 40 PVC - WITH TEST PLUG	POLISHED CHROME	01580 2	1	2 lbs.	
650ABSTP	1 1/2" SCH 40 ABS - WITH TEST PLUG	POLISHED CHROME	02108 7	1	2 lbs.	
SCH. 40 - ROLLER BALL STOP - U.S. PATENT # 5,428,847 - ONE HOLE FACE PLATE						
653PVC	1 1/2" SCH 40 PVC	POLISHED CHROME	71000 4	5	11 lbs.	
653ABS	1 1/2" SCH 40 ABS	POLISHED CHROME	70999 2	5	11 lbs.	
SCH. 40 - ROLLERBALL STOP - U.S. PATENT # 5,428,847 - HALF PAK LESS PIPE & TEE						
651PVC	1 1/2" SCH 40 PVC	POLISHED CHROME	70368 6	5	7 lbs.	
651PVCDS	1 1/2" SCH 40 PVC	PVD/POLISHED BRASS*	00241 3	5	7 lbs.	
651PVCWH	1 1/2" SCH 40 PVC	WHITE	71294 7	5	7 lbs.	
651ABS	1 1/2" SCH 40 ABS	POLISHED CHROME	00651 0	5	7 lbs.	
SCH. 40 - ROLLERBALL STOP - U.S. PATENT # 5,428,847 - ONE HOLE FACE PLATE HALF PAK LESS PIPE & TEE						
652PVC	1 1/2" SCH 40 PVC	POLISHED CHROME	70336 5	5	10 lbs.	
652PVCDS	1 1/2" SCH 40 PVC	PVD/POLISHED BRASS*	00248 2	5	10 lbs.	
652PVCWH	1 1/2" SCH 40 PVC	WHITE	71272 5	5	10 lbs.	
652ABS	1 1/2" SCH 40 ABS	POLISHED CHROME	70749 3	5	10 lbs.	
652ABSDES	1 1/2" SCH 40 ABS	PVD/POLISHED BRASS*	00249 9	5	10 lbs.	

SCHEDULE 40 DRAINS

SEAL²TEST

Part Num.	Item Description	Exposed Trim	UPC# 046224 +	Ctn Qty	Ctn Wt	Line Art
-----------	------------------	--------------	---------------	---------	--------	----------

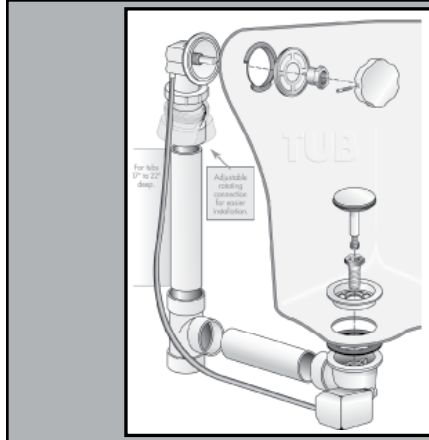

Reference below for product details

CABLE DRIVEN BATH DRAIN

- NO LINKAGE ADJUSTMENT NECESSARY
- INCLUDES OVERFLOW PROTECTION
- LARGE EASY-TO-TURN HANDLE FOR EASY OPENING AND CLOSING DRAIN
- ADJUSTABLE ROTATING CONNECTION FOR EASIER INSTALLATION
- AVAILABLE IN 6 POPULAR FINISHES

SCH. 40 - CABLE DRIVEN BATH DRAIN (SHOWN IN DETAIL ABOVE)

FITS MOST HOT TUBS, WHIRLPOOL TYPE & REGULAR BATHS 17" TO 22" DEEP

RECOMMENDED FOR USE ON FIBERGLASS, CAST IRON, ACRYLIC, MARBLE OR STEEL TUBS

645PVC	1 1/2" SCH 40 PVC	POLISHED CHROME	00645 9	5	13 lbs.
645PVCWH	1 1/2" SCH 40 PVC	WHITE	06451 0	5	13 lbs.
645PVCBN	1 1/2" SCH 40 PVC	BONE	06453 4	5	13 lbs.
645PVCBS	1 1/2" SCH 40 PVC	BISCUIT	06454 1	5	13 lbs.
645PVCDS	1 1/2" SCH 40 PVC	PVD/POLISHED BRASS*	01376 1	1	4 lbs.
645PVCDSBN	1 1/2" SCH 40 PVC	PVD/BRUSHED NICKEL*	01377 8	1	4 lbs.
645PVCDSPB	1 1/2" SCH 40 PVC	PVD/POLISHED BRASS*	01582 6	1	4 lbs.
645ABS	1 1/2" SCH 40 ABS	POLISHED CHROME	10645 6	5	13 lbs.
645ABSPB	1 1/2" SCH 40 ABS	POLISHED BRASS	02107 0	1	4 lbs.
645ABSDBN	1 1/2" SCH 40 ABS	PVD/BRUSHED NICKEL*	02106 3	1	4 lbs.

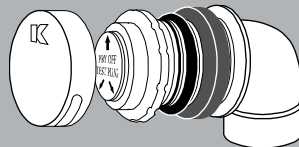
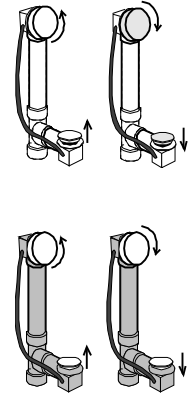

The screw on test cap allows for a one-man installation. Pry-Off the Overflow Test Plug with a knife or a screwdriver and Snap-on the decorative faceplate. Simple to Install... Simple to Test...

patent pending

SEAL²TEST BATH DRAIN

- CREATES A DOUBLE SEAL- INSIDE & OUTSIDE THE TUB WALL
- O-RING ENSURES "LEAK-FREE" TESTING
 - INSTALLS QUICKLY AND EASILY
- OVERFLOW OPENING REMAINS SEALED EVEN WHEN THE FACEPLATE IS REMOVED
- AVAILABLE IN PVC & ABS SCHEDULE 40
- AVAILABLE IN 11 POPULAR FINISHES

SEAL²TEST BATH DRAIN - OUR NEWEST IDEA IN THE FIGHT AGAINST LEAKS AND MOLD!

NEW OVERFLOW KITS WITH BATH DRAINS - LIFT 'N TURN (PATENT PENDING)

New

690PVC	1 1/2" SCH 40 PVC - POLISHED CHROME	00964 1	12	18 lbs.
690PVCWH	1 1/2" SCH 40 PVC - WHITE	01017 3	12	18 lbs..
690PVCDS	1 1/2" SCH 40 PVC - PVD/POLISHED BRASS*	01018 0	12	18 lbs.
690PVCDSBN	1 1/2" SCH 40 PVC - PVD/BRUSHED NICKEL*	02070 7	12	18 lbs.
690PVCSSN	1 1/2" SCH 40 PVC - PVD/SATIN NICKEL*	01035 7	12	18 lbs.

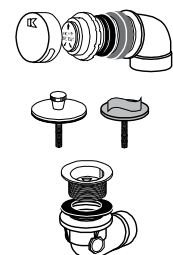

Part Num.	Item Description	Exposed Trim	UPC# 046224 +	Ctn Qty	Ctn Wt	Line Art
690PVCORB	1 1/2" SCH 40 PVC - OIL RUBBED BRONZE*		02034 9	1	2 lbs.	
690PVC PN	1 1/2" SCH 40 PVC - PVD/POLISHED NICKEL*		02028 8	1	2 lbs.	
690PVCSC	1 1/2" SCH 40 PVC - PVD/SATIN CHROME*		02016 5	1	2 lbs.	
690PVCSS	1 1/2" SCH 40 PVC - PVD/STAINLESS STEEL*		02021 9	1	2 lbs.	
690PVCVB	1 1/2" SCH 40 PVC - VENETIAN BRONZE*		02040 0	1	2 lbs.	
690PVCBSQ	1 1/2" SCH 40 PVC - BISCUIT		02069 1	12	18 lbs.	
690PVCDS PRN	1 1/2" SCH 40 PVC - PVD/PEARL NICKEL*		02068 4	12	18 lbs.	
690ABS	1 1/2" SCH 40 ABS - POLISHED CHROME		01047 0	12	18 lbs.	
690ABS WH	1 1/2" SCH 40 ABS - WHITE		01124 8	12	18 lbs.	
690ABS DS	1 1/2" SCH 40 ABS - PVD/POLISHED BRASS*		01130 9	12	18 lbs.	
690ABS DSBN	1 1/2" SCH 40 ABS - PVD/BRUSHED NICKEL*		02067 7	12	18 lbs.	
690ABS DSSN	1 1/2" SCH 40 ABS - PVD/SATIN NICKEL*		01254 2	12	18 lbs..	
690ABS ORB	1 1/2" SCH 40 ABS - OIL RUBBED BRONZE*		02035 6	1	2 lbs.	
690ABS PN	1 1/2" SCH 40 ABS - PVD/POLISHED NICKEL*		02029 5	1	2 lbs.	
690ABS SC	1 1/2" SCH 40 ABS - PVD/SATIN CHROME*		02017 2	1	2 lbs.	
690ABS SS	1 1/2" SCH 40 ABS - PVD/STAINLESS STEEL*		02022 6	1	2 lbs.	
690ABS VB	1 1/2" SCH 40 ABS - VENETIAN BRONZE*		02041 7	1	2 lbs.	
690ABS BSQ	1 1/2" SCH 40 ABS - BISCUIT		02065 3	12	18 lbs.	
690ABS DS PRN	1 1/2" SCH 40 ABS - PVD/PEARL NICKEL*		02066 0	12	18 lbs.	
SEAL²TEST BATH DRAIN - OUR NEWEST IDEA IN THE FIGHT AGAINST LEAKS AND MOLD!						
NEW OVERFLOW KITS WITH BATH DRAINS - ROLLER BALL (PATENT PENDING)						
691PVC	1 1/2" SCH 40 PVC - POLISHED CHROME		01257 3	12	18 lbs.	
691PVC WH	1 1/2" SCH 40 PVC - WHITE		01258 0	12	18 lbs.	
691PVC DS	1 1/2" SCH 40 PVC - PVD/POLISHED BRASS*		01259 7	12	18 lbs.	
691PVC DSBN	1 1/2" SCH 40 PVC - PVD/BRUSHED NICKEL*		02077 6	12	18 lbs.	
691PVC DSSN	1 1/2" SCH 40 PVC - PVD/SATIN NICKEL*		01260 3	12	18 lbs.	
691PVCORB	1 1/2" SCH 40 PVC - OIL RUBBED BRONZE*		02036 3	1	2 lbs.	
691PVC PN	1 1/2" SCH 40 PVC - PVD/POLISHED NICKEL*		02030 1	1	2 lbs.	
691PVCSC	1 1/2" SCH 40 PVC - PVD/SATIN CHROME*		02018 9	1	2 lbs.	
691PVCSS	1 1/2" SCH 40 PVC - PVD/STAINLESS STEEL*		02023 3	1	2 lbs.	
691PVCVB	1 1/2" SCH 40 PVC - VENETIAN BRONZE*		02042 4	1	2 lbs.	
691PVCBSQ	1 1/2" SCH 40 PVC - BISCUIT		02080 6	12	18 lbs.	
691PVCDS PRN	1 1/2" SCH 40 PVC - PVD/PEARL NICKEL*		02081 3	12	18 lbs.	
691ABS	1 1/2" SCH 40 ABS - POLISHED CHROME		01261 0	12	18 lbs.	
691ABS WH	1 1/2" SCH 40 ABS - WHITE		01262 7	12	18 lbs.	
691ABS DS	1 1/2" SCH 40 ABS - PVD/POLISHED BRASS*		01263 4	12	18 lbs.	
691ABS DSBN	1 1/2" SCH 40 ABS - PVD/BRUSHED NICKEL*		02078 3	12	18 lbs.	
691ABS DSSN	1 1/2" SCH 40 ABS - PVD/SATIN NICKEL*		01264 1	12	18 lbs.	
691ABS ORB	1 1/2" SCH 40 ABS - OIL RUBBED BRONZE*		02037 0	1	2 lbs.	
691ABS PN	1 1/2" SCH 40 ABS - PVD/POLISHED NICKEL*		02031 8	1	2 lbs.	
691ABS SC	1 1/2" SCH 40 ABS - PVD/SATIN CHROME*		02019 6	1	2 lbs.	
691ABS SS	1 1/2" SCH 40 ABS - PVD/STAINLESS STEEL*		02025 7	1	2 lbs.	
691ABS VB	1 1/2" SCH 40 ABS - VENETIAN BRONZE*		02043 1	1	2 lbs.	
691ABS BSQ	1 1/2" SCH 40 ABS - BISCUIT		02079 0	12	18 lbs.	
691ABS DS PRN	1 1/2" SCH 40 ABS - PVD/PEARL NICKEL*		02082 0	12	18 lbs.	

New

* "PVD" is a tarnish free product

SPECIALTY DRAINS

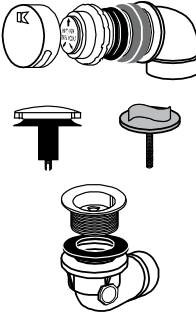
Part Num.	Item Description	Exposed Trim	UPC# 046224 +	Ctn Qty	Ctn Wt	Line Art
SEAL²TEST BATH DRAIN - OUR NEWEST IDEA IN THE FIGHT AGAINST LEAKS AND MOLD!						
NEW OVERFLOW KITS WITH BATH DRAINS - FOOT LOK STOP™ (PATENT PENDING)						
692PVC	1 1/2" SCH 40 PVC - POLISHED CHROME		01272 6	12	18 lbs.	
692PVCWH	1 1/2" SCH 40 PVC - WHITE		01273 3	12	18 lbs.	
692PVCDS	1 1/2" SCH 40 PVC - PVD/POLISHED BRASS*		01274 0	12	18 lbs.	
692PVCDSBN	1 1/2" SCH 40 PVC - PVD/BRUSHED NICKEL*		02072 1	12	18 lbs.	
692PVCDSN	1 1/2" SCH 40 PVC - PVD/SATIN NICKEL*		01278 8	12	18 lbs.	
692PVCORB	1 1/2" SCH 40 PVC - OIL RUBBED BRONZE*		02038 7	1	2 lbs.	
692PVCN	1 1/2" SCH 40 PVC - PVD/POLISHED NICKEL*		02032 5	1	2 lbs.	
692PVCSC	1 1/2" SCH 40 PVC - PVD/SATIN CHROME*		02020 2	1	2 lbs.	
692PVCSS	1 1/2" SCH 40 PVC - PVD/STAINLESS STEEL*		02026 4	1	2 lbs.	
692PVCVB	1 1/2" SCH 40 PVC - VENETIAN BRONZE*		02044 8	1	2 lbs.	
692PVCBSQ	1 1/2" SCH 40 PVC - BISCUIT		02071 4	12	18 lbs.	
692PVCDSPRN	1 1/2" SCH 40 PVC - PVD/PEARL NICKEL*		02073 8	12	18 lbs.	
692ABS	1 1/2" SCH 40 ABS - POLISHED CHROME		01317 4	12	18 lbs.	
692ABSWH	1 1/2" SCH 40 ABS - WHITE		01659 5	12	18 lbs.	
692ABSDES	1 1/2" SCH 40 ABS - PVDPOLISHED BRASS*		01660 1	12	18 lbs.	
692ABSDESBN	1 1/2" SCH 40 ABS - PVD/BRUSHED NICKEL*		02076 9	12	18 lbs.	
692ABSDESN	1 1/2" SCH 40 ABS - PVD/SATIN NICKEL*		01661 8	12	18 lbs.	
692ABSORB	1 1/2" SCH 40 ABS - OIL RUBBED BRONZE*		02039 4	1	2 lbs.	
692ABSPN	1 1/2" SCH 40 ABS - PVD/POLISHED NICKEL*		02033 2	1	2 lbs.	
692ABSSC	1 1/2" SCH 40 ABS - PVD/SATIN CHROME*		02046 2	1	2 lbs.	
692ABSSS	1 1/2" SCH 40 ABS - PVD/STAINLESS STEEL*		02027 1	1	2 lbs.	
692ABSVB	1 1/2" SCH 40 ABS - VENETIAN BRONZE*		02045 5	1	2 lbs.	
692ABSBSQ	1 1/2" SCH 40 ABS - BISCUIT		02074 5	12	18 lbs.	
692ABSDESPRN	1 1/2" SCH 40 ABS - PVD/PEARL NICKEL*		02075 2	12	18 lbs.	

New

SEAL²TEST BATH DRAIN ROUGH IN PACK KIT

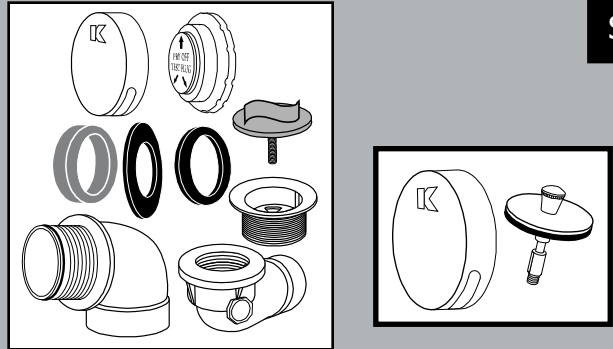

- CREATES A DOUBLE SEAL- INSIDE & OUTSIDE THE TUB WALL
- O-RING ENSURES "LEAK-FREE" TESTING
 - INSTALLS QUICKLY AND EASILY
- OVERFLOW OPENING REMAINS SEALED EVEN WHEN THE FACEPLATE IS REMOVED
 - AVAILABLE IN PVC SCHEDULE 40

**ROUGH IN PACK KITS - SCH. 40 BATH DRAIN WITH TEST PLUG KIT
LESS SCH. 40 TUBE AND TRIM FINISH**

New

690TKPVC	POLISHED CHROME TRIM FINISH KIT LIFT 'N TURN - BOXED		01959 6	10	9 lbs.
690TKPVCDS	PVD/POLISHED BRASS TRIM FINISH* KIT LIFT 'N TURN - BOXED		02144 5	10	4 lbs.
690RKPVC	PVC BATH DRAIN ROUGH N PACK KIT - BOXED		01958 9	10	9 lbs.
690RKPVCDS	PVD/POLISHED BRASS TRIM FINISH* KIT LIFT 'N TURN - BOXED		02145 2	10	13 lbs.
690RKABS	ABS BATH DRAIN ROUGH N PACK KIT - BOXED		02213 8	10	13 lbs.

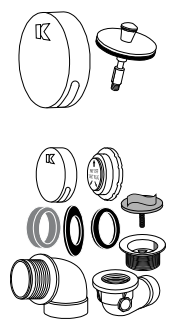

Part Num.	Item Description	Exposed Trim	UPC# 046224 +	Ctn Qty	Ctn Wt	Line Art
-----------	------------------	--------------	---------------	---------	--------	----------

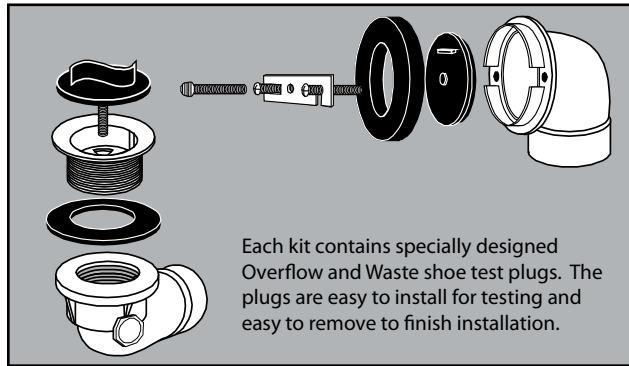

Each kit contains specially designed Overflow and Waste shoe test plugs. The plugs are easy to install for testing and easy to remove to finish installation.

BATH DRAIN ROUGH IN PACK KIT

PLUMBING CODES MAY REQUIRE DWV SYSTEMS BE PRESSURE TESTED TO ENSURE THAT THE INSTALLATION IS FREE OF LEAKS. THIS TEST INVOLVES PLUGGING ALL THE OPENINGS AND APPLYING HIGHER THAN NORMAL WORKING PRESSURE TO THE SYSTEM. THIS TYPE OF TESTING ENSURES THAT YOUR DWV SYSTEM IS PROPERLY INSTALLED WITHOUT THE POSSIBILITY OF WATER OR SEWER GASES ENTERING YOUR HOME.

SPECIALTY DRAINS

ROUGH IN KIT CONTRACTOR KITS - BAGGED - CONTAINS EVERYTHING NECESSARY

New

FOR A SCH. 40 BATH DRAIN WITH TEST PLUG KIT - LESS SCH. 40 TUBE AND TRIM FINISH

ROUGHINKITPV	PVC - ROUGH N PACK KIT	POLISHED CHROME	01100 2	10	10 lbs.
ROUGHNKITPBN	PVC - ROUGH N PACK KIT	PVD/BRUSHED NICKEL*	01347 1	10	10 lbs.
ROUGHINKITPW	PVC - ROUGH N PACK KIT	WHITE	01340 2	10	10 lbs.
ROUGHINKITBS	PVC - ROUGH N PACK KIT	BISCUIT	01947 3	10	10 lbs.
ROUGHINKITAB	ABS - ROUGH N PACK KIT	POLISHED CHROME	01210 8	10	10 lbs.
LIFNTURNTRIM	TRIM FINISH KIT - LIFT N TURN	POLISHED CHROME	01098 2	10	5 lbs.
LIFNTURNTRBS	TRIM FINISH KIT - LIFT N TURN	BISCUIT	01946 6	10	4 lbs.
LIFNTURNTRBN	TRIM FINISH KIT - LIFT N TURN	BRUSHED NICKEL	01349 5	10	4 lbs.
LIFNTURNTRMW	TRIM FINISH KIT - LIFT N TURN	WHITE	01339 6	10	4 lbs.
PUSHNPULTRIM	TRIM FINISH KIT - PUSH N PULL	POLISHED CHROME	01099 9	10	5 lbs.
PUSHNPULTRBN	TRIM FINISH KIT - PUSH N PULL	PVD/BRUSHED NICKEL*	01348 8	10	4 lbs.

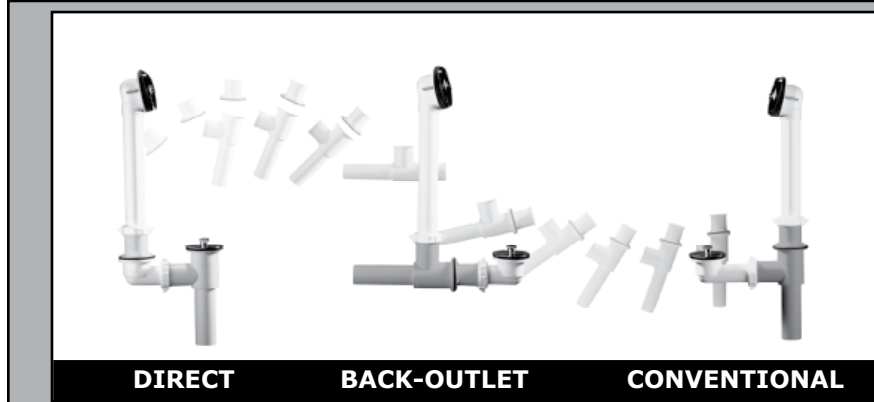
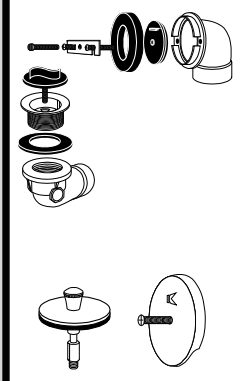

Transformation of a Triad

3 drains in 1!

THE "TRIAD" PROVIDES THREE SOLUTIONS TO EVERY BATH DRAIN INSTALLATION

TRIAD - U.S. PATENT # 4,920,582 - LIFT 'N TURN
THREE DRAINS IN ONE! - DIRECT, CONVENTIONAL, AND BACK-OUTLET DRAIN

70W	1 1/2" OD WHITE	POLISHED CHROME	93666 4	5	13 lbs.
70WDS	1 1/2" OD WHITE	PVD/POLISHED BRASS*	00228 4	5	13 lbs.

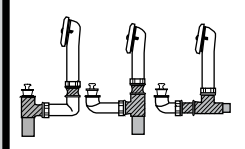

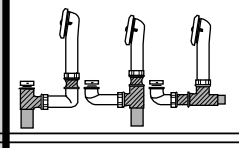

TRIAD - U.S. PATENT # 4,920,582 - FOOT LOCK STOP™
THREE DRAINS IN ONE! - DIRECT, CONVENTIONAL, AND BACK-OUTLET DRAIN

71W	1 1/2" WHITE	POLISHED CHROME	93707 4	5	7 lbs.
-----	--------------	-----------------	---------	---	--------



* "PVD" is a tarnish free product

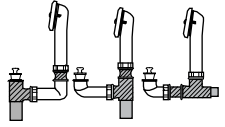
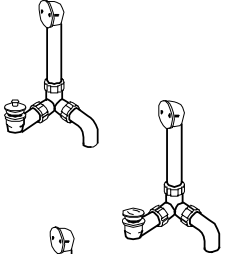
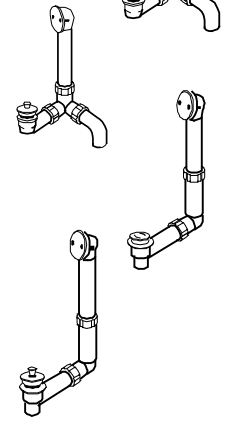
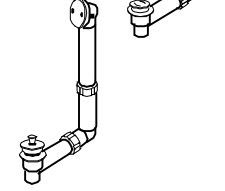







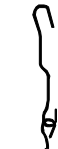

SPECIALTY DRAINS

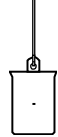
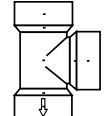
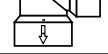
Part Num.	Item Description	Exposed Trim	UPC# 046224 +	Ctn Qty	Ctn Wt	Line Art
TRIAD - U.S. PATENT # 4,920,582 ROLLER BALL STOP - U.S. PATENT # 5,428,847						
THREE DRAINS IN ONE! - A DIRECT, CONVENTIONAL, AND BACK-OUTLET DRAIN						
86W	1 1/2" WHITE	POLISHED CHROME	70486 7	5	8 lbs.	
86WDS	1 1/2" WHITE	PVD/POLISHED BRASS*	00247 5	5	8 lbs.	
SIDE OUTLET BATHDRAIN - LIFT 'N TURN						
72W	1 1/2" WHITE	POLISHED CHROME	70224 5	5	8 lbs.	
SIDE OUTLET BATHDRAIN - FOOT LOK STOP™						
77W	1 1/2" WHITE	POLISHED CHROME	70225 2	5	8 lbs.	
SIDE OUTLET-ROLLER BALL - U.S. PATENT # 5,428,847						
87W	1 1/2" WHITE	POLISHED CHROME	70378 5	5	8 lbs.	
DIRECT OUTLET - FOOT LOK STOP™						
68W	1 1/2" WHITE	POLISHED CHROME	93653 4	5	8 lbs.	
DIRECT OUTLET - LIFT 'N TURN						
69W	1 1/2" OD WHITE	POLISHED CHROME	93662 6	5	6 lbs.	
69WDS	1 1/2" OD WHITE	PVD/POLISHED BRASS*	00230 4	5	6 lbs.	
FOOT LOK ASSEMBLIES						
63-1CF	5/16" THREADED SHAFT WITH STRAINER	POLISHED CHROME	93560 5	10	5 lbs.	
63-1CFAN	5/16" THREADED SHAFT WITH STRAINER	ANTIQUE BRASS	93561 2	10	5 lbs.	
63-1CFPB	5/16" THREADED SHAFT WITH STRAINER	POLISHED BRASS	93562 9	10	5 lbs.	
63-1F	CARTRIDGE ONLY	POLISHED CHROME	93563 6	10	2 lbs.	
63-1FAN	CARTRIDGE ONLY	ANTIQUE BRASS	93564 3	10	2 lbs.	
63-1FPB	CARTRIDGE ONLY	POLISHED BRASS	93565 0	10	2 lbs.	
63-50PC	WEST COAST CARTRIDGE - 3/8" THREADED SHAFT	POLISHED CHROME	93568 1	10	2 lbs.	
63-50AN	WEST COAST CARTRIDGE - 3/8" THREADED SHAFT	ANTIQUE BRASS	72247 2	10	2 lbs.	
63-50PB	WEST COAST CARTRIDGE - 3/8" THREADED SHAFT	POLISHED BRASS	70753 0	10	2 lbs.	
63-51PC	FOOT LOK WEST COAST STRAINER ONLY - 3/8" THREAD	POLISHED CHROME	93570 4	10	2 lbs.	

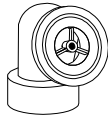
Part Num.	Item Description	Exposed Trim	UPC# 046224 +	Ctn Qty	Ctn Wt	Line Art
LIFT 'N TURN ASSEMBLY						
62-1CF	BRASS	POLISHED CHROME	93501 8	10	6 lbs.	
62-1CFPB	BRASS	POLISHED BRASS	93503 2	10	6 lbs.	
62-3F	LIFT N TURN WITH STRAINER	POLISHED CHROME	93504 9	10	6 lbs.	
ROLLER BALL STOP ASSEMBLY U.S. PATENT #5,428,847						
63-4PC	ROLLER BALL STOP ASSEMBLY	POLISHED CHROME	71002 8	10	2 lbs.	
63-4AN	ROLLER BALL STOP ASSEMBLY	ANTIQUE BRASS	72248 9	10	2 lbs.	
63-4WHT	ROLLER BALL STOP ASSEMBLY	WHITE	73302 7	10	2 lbs.	
MECHANICAL POP-UP ASSEMBLIES						
617-4	ROCKER ARM ASSEMBLY		93498 1	25	3 lbs.	
FACE PLATES						
620-10PC	SINGLE HOLE OVERFLOW	POLISHED CHROME	93525 4	25	4 lbs.	
606-2PC	FACE PLATE SCREW	POLISHED CHROME	93448 6	50	2 lbs.	
606-1PC	TRIPLEVER WITH SCREWS & COTTER PIN	POLISHED CHROME	93441 7	25	7 lbs.	
WASTE SHOES - WITH STRAINER						
616SN	1 3/8"		93495 0	6	5 lbs.	
614RB	1 1/2" ROUGH BRASS - FINE THREAD		93490 5	6	5 lbs.	
6141RB	1 1/2" ROUGH BRASS - COARSE THREAD		93491 2	6	7 lbs.	
PLASTIC WASTE SHOES						
64-6PVC	1 1/2" OD X 6 1/2" WHITE		93592 6	25	3 lbs.	
64-6ABS	1 1/2" OD X 6 1/2" BLACK		71025 7	25	3 lbs.	
LINKAGE ASSEMBLY FOR PLASTIC						
64-14PVC	FOR TRIPLEVER 6" EYE WIRE, 10-32 BRASS EYE BOLT & CLEVIS PLUNGER WHITE		93589 6	25	1 lb.	
64-14ABS	FOR TRIPLEVER 6" EYE WIRE, 10-32 BRASS EYE BOLT & CLEVIS PLUNGER BLACK		71053 0	25	1 lb.	

BATH DRAIN
ACCESSORIES

BATH DRAIN ACCESSORIES

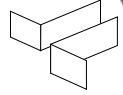
Part Num.	Item Description	Exposed Trim	UPC# 046224 +	Ctn Qty	Ctn Wt	Line Art
QUICK ADJUST LINKAGE ASSEMBLIES						
640-14W	FOR TRIPLEVER, 606-53 TWO PIECE EYE WIRE, 606-54 BRASS HEX NUTS (2), 64-9 PLASTIC PLUNGER, ADJ LINKAGE CONTROL 606-54, DBL. EYE WIRE 606-10,.. ADJ. FROM 11" TO 14 3/4" WHITE PLUNGER		71026 4	5	11 lbs.	
641-14W	FOR TRIPLEVER 1/2 PAK, 606-51 TOP EYE WIRE, 606-54 BRASS HEX NUTS (2), 64-9 PLASTIC PLUNGER, ADJ. LINKAGE CONTROL 606-50, DOUBLE EYE WIRE 606-55. ADJ. FROM 14" TO 21 11/16", WHITE PLUNGER		71031 8	5	11 lbs.	
641-14B	FOR TRIPLEVER 1/2 PAK, 606-51 TOP EYE WIRE, 606-54 BRASS HEX NUTS (2), 64-9 PLASTIC PLUNGER, ADJ. LINKAGE CONTROL 606-50, DOUBLE EYE WIRE 606-55. ADJ. FROM 14" TO 21 11/16", BLACK PLUNGER		71032 5	5	11 lbs.	
SCHEDULE 40 TRIPLEVER TEES						
620-9W	1 1/2" PVC SANITARY TRIPLEVER TEE		71034 9	25	8 lbs.	
620-9B	1 1/2" ABS SANITARY TRIPLEVER TEE		71033 2	25	8 lbs.	
SCHEDULE 40 OVERFLOWS						
620-2W	1 1/2" PVC - TWO HOLE		93528 5	25	5 lbs.	
620-2B	1 1/2" ABS - TWO HOLE		93526 1	25	5 lbs.	
620-2LAPVC	1 1/2" PVC - ONE HOLE		72175 8	25	5 lbs.	
620-2LAABS	1 1/2" ABS - ONE HOLE		72176 5	25	5 lbs.	
SCHEDULE 40 WASTE SHOES						
620-3W	1 1/2" PVC - THREADED		93530 8	25	6 lbs.	
620-3B	1 1/2" ABS - THREADED		93529 2	25	6 lbs.	
WASHERS						
622RU	RUBBER WASTE STRAINER WASHER		93552 0	100	1 lb.	
20879RU	WASTE SHOE WASHER		92286 5	100	1 lb.	
1308LRU	TUB OVERFLOW WASHER		92008 3	100	2 lbs.	
64-3M	TUB TACK		93590 2	100	1 lb.	

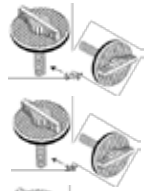
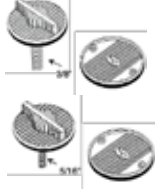
Part Num.	Item Description	Exposed Trim	UPC# 046224 +	Ctn Qty	Ctn Wt	Line Art
TEST PLUG KIT FOR SCH 40 BATHDRAINS						
620-7G	TEST PLUG FOR SINGLE HOLE OVERFLOW - GREY		00306 9	25	12 lbs.	
620-7B	TEST PLUG FOR SINGLE HOLE OVERFLOW - BLACK		00117 1	25	12 lbs.	
TEST PLUG KIT FOR SCH 40 BATHDRAINS - TWO HOLE						
620-8B	TEST PLUG FOR TWO HOLE OVERFLOW - BLACK		00208 6	25	12 lbs.	
620-8G	TEST PLUG FOR TWO HOLE OVERFLOW - GREY		00207 9	25	12 lbs.	

BATH DRAIN
ACCESSORIES